



*Solutions for AC Drives*

# **Model M3628PUD Ultracapacitor Discharge Module**

## **Customer Reference Manual**

**Bonitron, Inc.**  
Nashville, TN



*An industry leader in providing solutions for AC drives.*

## **ABOUT BONITRON**

Bonitron designs and manufactures quality industrial electronics that improve the reliability of processes and variable frequency drives worldwide. With products in numerous industries, and an educated and experienced team of engineers, Bonitron has seen thousands of products engineered since 1962 and welcomes custom applications.

With engineering, production, and testing all in the same facility, Bonitron is able to ensure its products are of the utmost quality and ready to be applied to your application.

The Bonitron engineering team has the background and expertise necessary to design, develop, and manufacture the quality industrial electronic systems demanded in today's market. A strong academic background supported by continuing education is complemented by many years of hands-on field experience. A clear advantage Bonitron has over many competitors is combined on-site engineering labs and manufacturing facilities, which allows the engineering team to have immediate access to testing and manufacturing. This not only saves time during prototype development, but also is essential to providing only the highest quality products.

The sales and marketing teams work closely with engineering to provide up-to-date information and provide remarkable customer support to make sure you receive the best solution for your application. Thanks to this combination of quality products and superior customer support, Bonitron has products installed in critical applications worldwide.

## AC DRIVE OPTIONS

In 1975, Bonitron began working with AC inverter drive specialists at synthetic fiber plants to develop speed control systems that could be interfaced with their plant process computers. Ever since, Bonitron has developed AC drive options that solve application issues associated with modern AC variable frequency drives and aid in reducing drive faults. Below is a sampling of Bonitron's current product offering.

## WORLD CLASS PRODUCTS

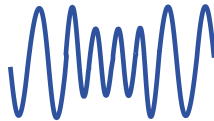

**Undervoltage Solutions**  
Uninterruptible Power for Drives  
(DC Bus Ride-Thru)  
Voltage Regulators  
Chargers and Dischargers  
Energy Storage

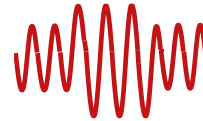

**Overvoltage Solutions**  
Braking Transistors  
Braking Resistors  
Transistor/Resistor Combo  
Line Regeneration  
Dynamic Braking for Servo Drives

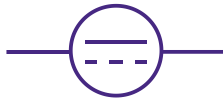

**Common Bus Solutions**  
Single Phase Power Supplies  
3-Phase Power Supplies  
Common Bus Diodes



**Portable Maintenance Solutions**  
Capacitor Formers  
Capacitor Testers

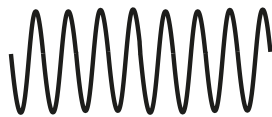

**Power Quality Solutions**  
12 and 18 Pulse Kits



**Green Solutions**  
Line Regeneration

*This page intentionally left blank.*

---

# Table of Contents

<b>1. INTRODUCTION .....</b>	<b>7</b>
1.1. Who Should Use .....	7
1.2. Purpose and Scope .....	7
1.3. Manual Version and Change Record .....	7
Figure 1-1: M3628PUD .....	7
1.4. Symbol Conventions Used in this Manual and on Equipment .....	8
<b>2. PRODUCT DESCRIPTION .....</b>	<b>9</b>
2.1. Related Products .....	9
2.2. Part Number Breakdown .....	10
Figure 2-1: Example of Part Number Breakdown .....	10
Table 2-1: Capacitor Voltage .....	10
Table 2-2: Capacitance Rating .....	10
2.3. General Specifications .....	12
Table 2-3: General Specifications Table .....	12
General Precautions and Safety Warnings .....	13
<b>3. INSTALLATION INSTRUCTIONS .....</b>	<b>14</b>
3.1. Environment .....	14
3.2. Wiring and Customer Connections .....	14
3.2.1. Power Wiring .....	14
Figure 3-1: M3628PUD .....	14
3.2.1. Discharge Connections .....	14
3.2.2. Source Considerations .....	15
<b>4. OPERATION .....</b>	<b>16</b>
4.1. Functional Description.....	16
The M3628PUD module is powered by plugging in the 120V or the 240V line cord. The module uses a switch to close a DC contactor across an internal resistor. When the switch is placed in the “DISCHARGE ON” position, the voltage on the Ultra-capacitor module will decrease to a safe level within 60 seconds. Once the digital display indicates that the capacitor is drained, the discharge switch can be placed in the “DISCHARGE OFF” position until the exhaust air from the discharger is close to ambient room temperature. ....	16
4.2. Circuit Schematic.....	16
Figure 4-1: M3628UMT Schematic .....	16
4.3. Hardware Features .....	17
4.3.1. AC Power Input Connector .....	17
4.3.2. Power Switch / Circuit Breaker .....	17
4.3.3. Discharge switch.....	17
4.3.4. DC Capacitor Connectors .....	17
4.3.5. Display .....	17
4.3.6. Discharge Resistor .....	17
4.3.7. Cooling fan .....	17
<b>5. STARTUP AND TROUBLESHOOTING.....</b>	<b>18</b>
5.1.1. Pre-power checks .....	18
5.1.2. Discharge Procedure .....	18
5.2. Troubleshooting .....	19
Table 5-1: Discharge System Troubleshooting .....	19
<b>6. ENGINEERING DATA .....</b>	<b>20</b>
6.1. Ratings Chart .....	20
Table 6-1: Ratings Chart .....	20
Table 6-2: Dimensions .....	20



## 1. INTRODUCTION

### 1.1. WHO SHOULD USE

This manual is intended for use by trained personnel responsible for maintaining or testing ultra-capacitor cells and modules.

Please keep this manual for future reference.

### 1.2. PURPOSE AND SCOPE

This manual is a user's guide for the model M3628PUD. It will provide the user with the necessary information to successfully connect and operate the M3628PUD.

In the event of any conflict between this document and any publication and/or documentation related to any associated hardware (capacitor bank, etc.), the latter shall have precedence.

### 1.3. MANUAL VERSION AND CHANGE RECORD







The initial release for this module is Rev 00a.

Added info about the 96V 83 farad module in Rev 00b.

**Figure 1-1: M3628PUD**



**1.4. SYMBOL CONVENTIONS USED IN THIS MANUAL AND ON EQUIPMENT**

	<p>Earth Ground or Protective Earth</p>
	<p>AC Voltage</p>
	<p>DC Voltage</p>
 <p>DANGER!</p>	<p>DANGER: Electrical hazard - Identifies a statement that indicates a shock or electrocution hazard that must be avoided.</p>
 <p>DANGER!</p>	<p>DANGER: Identifies information about practices or circumstances that can lead to personal injury or death, property damage, or economic loss.</p>
 <p>CAUTION!</p>	<p>CAUTION: Identifies information about practices or circumstances that can lead to property damage, or economic loss. Attentions help you identify a potential hazard, avoid a hazard, and recognize the consequences.</p>
 <p>CAUTION!</p>	<p>CAUTION: Heat or burn hazard - Identifies a statement regarding heat production or a burn hazard that should be avoided.</p>



## 2. PRODUCT DESCRIPTION

The M3628PUD portable discharger is designed to deplete energy stored in Ultra cap modules for industrial power use. The unit can be powered from the supplied 115vac line cord or the supplied 230vac line cord. This portable discharger contains DC contactor and resistor element to discharge the capacitor, with 6' leads to the capacitor terminal and 6' power cord. The discharger module also contains a digital display for capacitor voltage and a temperature sensor for safety. The unit is equipped with a fan for cooling the resistor element and is capable of a full discharge cycle every 2 minutes with the fan running.

### 2.1. RELATED PRODUCTS

#### **M5628 ULTRA CAPACITOR/ BATTERY CHARGER**

The M5628 charger can charge strings of batteries or ultra-capacitors to voltages required for industrial and commercial applications. The charger is current limited, and designed for use in integrated storage and backup systems, but can also be used in bench or mobile systems.

#### **KIT 3628T ULTRA CAPACITOR STRING DISCHARGER**

Large capacitor banks store huge amounts of energy, and can be a hazard when systems are shut down for system maintenance. The KIT 3628T system discharges capacitor banks to safe working levels quickly, allowing work on the system to begin in seconds, rather than hours.

#### **M3628UMT ULTRA CAPACITOR MODULE TESTER**

The M3628UMT is a portable, digitally controlled DC power supply and capacitor test system with a variable output voltage and current limit. It can perform accurate, informative measurements of an ultra-capacitor's capacitance and ESR.

#### **M3628ACF AUTOMATIC CAPACITOR FORMER**

The M3628ACF automatic capacitor former can be used to reform capacitor banks as large as 150 kJ. The output voltage is programable between 0 and 1000 VDC, and is capable of supplying 1 ADC continuously.

## 2.2. PART NUMBER BREAKDOWN

**Figure 2-1: Example of Part Number Breakdown**

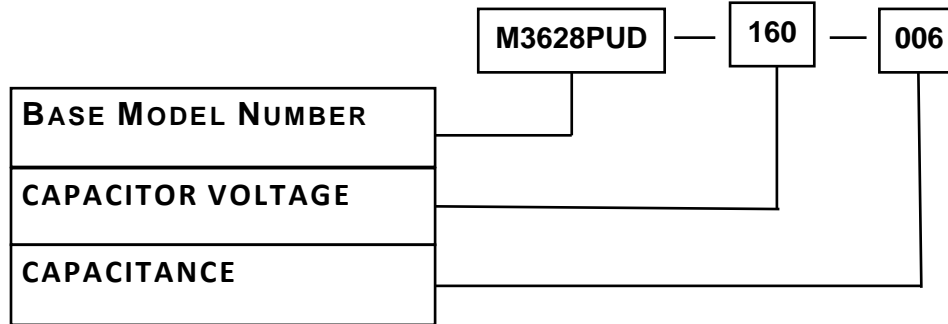

### BASE MODEL NUMBER

The base model number for all Ultra-Capacitor Discharge Module is M3628PUD.

### CAPACITOR VOLTAGE RATING

The Capacitor Voltage rating indicates the DC voltage rating for each capacitor module, the most common ratings are 16V, 48V, 96V and 160V. A three-digit code represents the capacitor voltage.

**Table 2-1: Capacitor Voltage**

<b>RATING CODE</b>	<b>DC DISCHARGE VOLTAGE</b>
<b>016</b>	16V (18V MAX)
<b>048</b>	48V (56V MAX)
<b>096</b>	96V (108V MAX)
<b>160</b>	160V (180V Max)

### CAPACITANCE RATING

A three digit code represents the module capacitance.

**Table 2-2: Capacitance Rating**

<b>RATING CODE</b>	<b>FARAD</b>
006	5.8F – 6F
058	58F – 62F
083	83F
166	165F – 166F
500	500F



### 2.3. GENERAL SPECIFICATIONS

**Table 2-3: General Specifications Table**

<b>PARAMETER</b>	<b>SPECIFICATION</b>
Input Voltage	85-264 VAC 1Ø 52 watts Max
Cooling	Forced Air
Display	3.5 Digit LED Display
Operating Temp Range	0°C to + 40°C
Storage Temp	-20°C to + 65°C
Humidity	Below 90% non-condensing
Atmosphere	Free of corrosive gas and conductive dust

## GENERAL PRECAUTIONS AND SAFETY WARNINGS



**ELECTROCUTION  
HAZARD!**

- **THIS UNIT PRODUCES VOLTAGES CAPABLE OF CAUSING INJURY OR DEATH!**
- **FOR USE BY QUALIFIED AND TRAINED PERSONNEL ONLY!**
- **IMPROPER OPERATION OF THE PRODUCT OR IGNORING THESE WARNINGS MAY RESULT IN SERIOUS BODILY INJURY OR DEATH!**
- **BEFORE CONNECTING THE M3628PUD TO A CAPACITOR, ENSURE THAT THE CAP MODULE IS DRY THEN MEASURE THE VOLTAGE USING VOLTMETER.**
- **CONNECTING THE M3628PUD'S VOLTAGE CABLE TO A CAP WITH THE POLARITY REVERSED CAN CAUSE DAMAGE TO YOUR CAP AND POTENTIALLY THE EQUIPMENT. ENSURE THAT THE POSITIVE AND NEGATIVE TERMINALS ON BOTH SIDES ARE POSITIVELY IDENTIFIED AND CORRECTLY CONNECTED BEFORE OPERATION.**
- **BEFORE POWERING UP THE MODULE, MAKE SURE THE DISCHARGE SWITCH IS IN (OFF) POSITION.**
- **NEVER OPERATE THIS PRODUCT WITH THE ENCLOSURE COVER REMOVED.**



**DANGER!**

- **NEVER ATTEMPT TO SERVICE THIS PRODUCT.**
- **CERTAIN PARTS INSIDE THIS PRODUCT MAY GET HOT DURING OPERATION.**
- **BEFORE CONNECTING THIS DEVICE TO ANY OTHER PRODUCT, BE SURE TO REVIEW ALL DOCUMENTATION OF THAT PRODUCT FOR PERTINENT SAFETY PRECAUTIONS.**

**ANY QUESTIONS AS TO APPLICATION, INSTALLATION, OR SERVICE SAFETY SHOULD BE DIRECTED TO THE EQUIPMENT SUPPLIER.**

## 3. INSTALLATION INSTRUCTIONS

### 3.1. ENVIRONMENT

While closed, the M3628PUD is water, dust, and crush resistant. When open and in operation, the unit should be used only in dry, clean areas. Ensure that the interior of the unit casing is kept dry.

### 3.2. WIRING AND CUSTOMER CONNECTIONS

#### 3.2.1. POWER WIRING

The Power Input connector accepts 50-60Hz from the standard C13 power cable. The unit will include the standard 120 VAC cable and the 240VAC cable .

**Figure 3-1: M3628PUD**

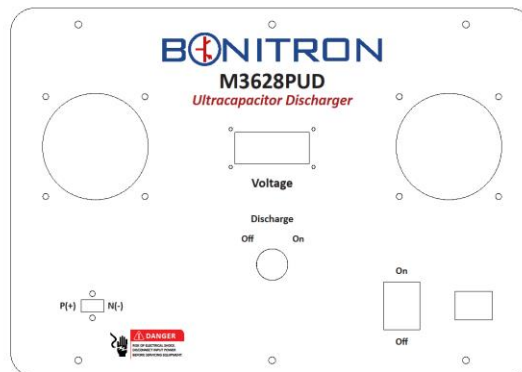

#### 3.2.1. DISCHARGE CONNECTIONS

The DC connections are POWERPOLE type connections. The M3638PUD-096-083, M3628PUD-048-166 and M3628PUD-016-500 units uses POWERPOLE PP75 connector. The M3628PUD-016-058 and M3628PUD-160-006 units use POWERPOLE 45 connectors. The included discharge cable will be six feet long with alligator clips at the end.

## 3.2.2. SOURCE CONSIDERATIONS

Input voltage should not exceed the rating—264VAC or damage to the unit may result. To guarantee correct system operation at all output voltages, the source must be capable of supplying at least 0.95 amps for 120VAC supply or 0.56 amps for a 240VAC supply. Failure to meet the minimum current requirement may result in improper operation. Connecting the unit to an input voltage other than that specified on the unit faceplate may also result in improper operation or damage to the unit.

## 4. OPERATION

### 4.1. FUNCTIONAL DESCRIPTION

The M3628PUD module is powered by plugging in the 120V or the 240V line cord. The module uses a switch to close a DC contactor across an internal resistor. When the switch is placed in the “DISCHARGE ON” position, the voltage on the Ultra-capacitor module will decrease to a safe level within 60 seconds. Once the digital display indicates that the capacitor is drained, the discharge switch can be placed in the “DISCHARGE OFF” position until the exhaust air from the discharger is close to ambient room temperature.

### 4.2. CIRCUIT SCHEMATIC

Electrically, the M3628PUD is a bleeding resistor and a DC contactor that are manually controlled by the Discharge switch. Additionally, the AC line input feeds an internal DC power supply. A temperature switch is installed near the resistor to stop the discharge process in case the unit overheats. If the unit overheats, the temp switch will open causing the contactor to open and stop discharging. once the unit cools down, the temp switch closes and the unit will go back to normal operation.

**Figure 4-1: M3628UMT Schematic**

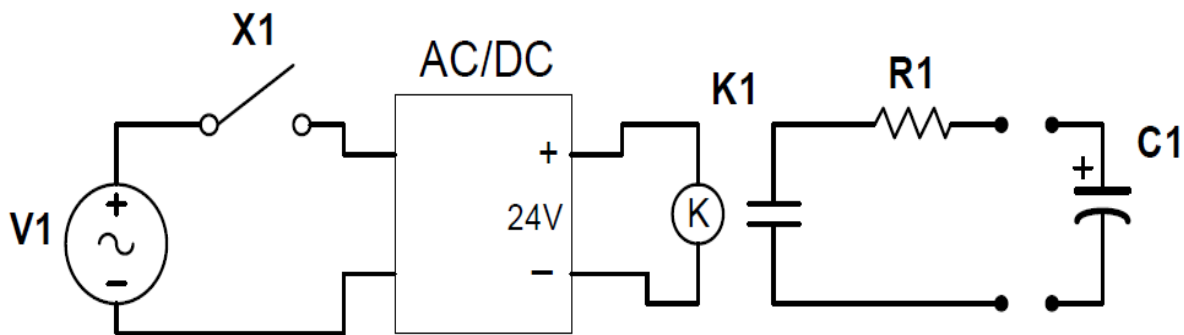



## 4.3. HARDWARE FEATURES

### 4.3.1. AC POWER INPUT CONNECTOR

The M3628PUD is equipped with a standard IEC C14 connector for input power. This connector mates with a standard C13 cable, commonly used with desktop computers, to provide power to the unit

### 4.3.2. POWER SWITCH / CIRCUIT BREAKER

The AC Power Switch also acts as a circuit breaker to protect from overload conditions. If the breaker is tripped, you can reset it by simply turning the switch off, then back on

### 4.3.3. DISCHARGE SWITCH

When the discharge switch is ON, the contactor will close putting the internal resistor across the Ultra-cap module and the unit will drain the energy stored in the cap within sixty seconds. The M3628PUD-096-083 will drain the energy stored in the cap within three hundred seconds.

### 4.3.4. DC CAPACITOR CONNECTORS

The M3638PUD-096-083, M3628PUD-048-166 and M3628PUD-016-500 units are equipped with Four PowerPole PP75 connectors, M3628PUD-016-058 and M3628PUD-160-006 units are equipped with two PowerPole PP45 connectors. The standard cables shipped with the system includes six foot long wires and two high-current alligator clips to allow the user to discharge the Ultra-Capacitor module.

### 4.3.5. DISPLAY

The digital display shows the present DC voltage on the Ultra-capacitor module.

### 4.3.6. DISCHARGE RESISTOR

The discharge resistor is designed to drain the energy stored in the Ultra-cap module within sixty seconds.

### 4.3.7. COOLING FAN

The internal fan run for continued cooling of the resistor element. Cooling back to room temperature may take up to 3 minutes after one full discharge cycle.

## 5. STARTUP AND TROUBLESHOOTING

### 5.1.1. PRE-POWER CHECKS

- Ensure DC is securely fastened to the plug.
- Ensure DC bus polarity is correct.
- Plug power cord into the 120/240VAC outlet.
- Turn ON discharge switch and ensure the contactor closes in DISCHARGE position **only**.
- Turn switch to **OFF** position.

### 5.1.2. DISCHARGE PROCEDURE



*Ensure the voltage rating of the system before connecting to cap module! Unit is designed for 1 minute drain of properly sized Ultra-Capacitor module.*



*Ensure M3628PUD switch is in the **OFF** position **BEFORE** connecting discharge cables to system. Connect cables one at a time, keeping one hand on the plug and the rest of your body away from any other potential or grounded surface. For additional safety, stand on insulated surface when connecting plugs.*

1. Disconnect any source that charges the ultra-capacitors.
2. Ensure that DISCHARGE switch is in the off position.
3. Connect the alligator clips to the ultra-capacitor.
4. Turn DISCHARGE switch to ON position.
  - Storage voltage should begin to decrease.
  - Load resistor will begin to heat up.
  - In approximately 1 minute the cap storage voltage should be around 5% to 10% of the cap voltage.
  - The M3628PUD will continue to drain cap bank as long as the unit is in DISCHARGE mode.
5. If excessive heat is noticed, the discharge cycle can be aborted by turning the DISCHARGE switch to OFF position at any time during the discharge cycle.
  - Internal temp sensor will automatically stop discharging in case of over temperature

## 5.2. TROUBLESHOOTING

Repairs or modifications to this equipment are to be performed by Bonitron approved personnel only. Any repair or modification to this equipment by personnel not approved by Bonitron will void any warranty remaining on this unit.

**Table 5-1: Discharge System Troubleshooting**

SYMPTOM	ACTION
Unit will not discharge Capacitor	<ul style="list-style-type: none"> <li>• Ensure switch is in the DISCHARGE position</li> <li>• Ensure the Ultra-capacitor is properly connected</li> <li>• Measure actual DC voltage across the cap               <ul style="list-style-type: none"> <li>• Ensure the display voltage is accurate</li> </ul> </li> </ul>
Unit will not allow Capacitor to charge	<ul style="list-style-type: none"> <li>• Ensure Discharge switch is in OFF position</li> <li>• Ensure proper connection to the M3628PUD module</li> </ul>
No Display voltage	<ul style="list-style-type: none"> <li>• Ensure power cord is plugged in to a 120/240VAC outlet</li> <li>• Ensure power switch in ON and it is not tripped.</li> <li>• Ensure all connectors are in place.</li> </ul>
OVER-TEMP	<ul style="list-style-type: none"> <li>• Measure temperature of the front panel               <ul style="list-style-type: none"> <li>• Measure temperature of resistor element.</li> <li>• If above 50°C, allow time to cool</li> </ul> </li> </ul>
Fan not running	<ul style="list-style-type: none"> <li>• Ensure power cord is plugged in to a 120/240VAC outlet</li> <li>• Ensure power switch in ON and it is not tripped.</li> </ul>



*Always monitor the output voltage while operating the unit. Ensure that the attached loads do not exceed their rated voltage, as catastrophic damage, injury, or death may occur.*

## 6. ENGINEERING DATA

### 6.1. RATINGS CHART

**Table 6-1: Ratings Chart**

BONITRON PART NUMBER	DC VOLTAGE RATING	MAX DISCHARGE CURRENT	RESISTANCE	MAX DISCHARGE TIME	CONTINUOUS WATTAGE
M3628PUD-016-058	16 VDC	32A	0.5 Ohm	60 Seconds	100 W
M3628PUD-016-500	16 VDC	307A	0.09 Ohm	60 Seconds	500W
M3628PUD-048-166	48VDC	288A	0.16 Ohm	60 Seconds	1200 W
M3628PUD-096-166	96VDC	80A	1.2 Ohm	300 Minutes	1200 W
M3628PUD-160-006	160 VDC	36A	5.0 Ohm	60 Seconds	400 W

**Table 6-2: Dimensions**

BONITRON PART NUMBER	OVERALL (INCHES)			WEIGHT (LBS.)
	HEIGHT	WIDTH	DEPTH	
M3628PUD-016-058	13.4	11.6	6.0	9
M3628PUD-016-500	16.4	13.0	6.8	19
M3628PUD-048-166	22.0	13.8	9.0	32
M3628PUD-096-083	22.0	13.8	9.0	32
M3628PUD-160-006	16.4	13.0	6.8	16

*This page intentionally left blank.*

*This page intentionally left blank.*

*This page intentionally left blank.*





---

*This page intentionally left blank.*

---

