



Model M3628UCT Ultracapacitor Cell Tester

Customer Reference Manual

Bonitron, Inc.
Nashville, TN



An industry leader in providing solutions for AC drives.

ABOUT BONITRON

Bonitron designs and manufactures quality industrial electronics that improve the reliability of processes and variable frequency drives worldwide. With products in numerous industries, and an educated and experienced team of engineers, Bonitron has seen thousands of products engineered since 1962 and welcomes custom applications.

With engineering, production, and testing all in the same facility, Bonitron is able to ensure its products are of the utmost quality and ready to be applied to your application.

The Bonitron engineering team has the background and expertise necessary to design, develop, and manufacture the quality industrial electronic systems demanded in today's market. A strong academic background supported by continuing education is complemented by many years of hands-on field experience. A clear advantage Bonitron has over many competitors is combined on-site engineering labs and manufacturing facilities, which allows the engineering team to have immediate access to testing and manufacturing. This not only saves time during prototype development, but also is essential to providing only the highest quality products.

The sales and marketing teams work closely with engineering to provide up-to-date information and provide remarkable customer support to make sure you receive the best solution for your application. Thanks to this combination of quality products and superior customer support, Bonitron has products installed in critical applications worldwide.

AC DRIVE OPTIONS

In 1975, Bonitron began working with AC inverter drive specialists at synthetic fiber plants to develop speed control systems that could be interfaced with their plant process computers. Ever since, Bonitron has developed AC drive options that solve application issues associated with modern AC variable frequency drives and aid in reducing drive faults. Below is a sampling of Bonitron's current product offering.

WORLD CLASS PRODUCTS

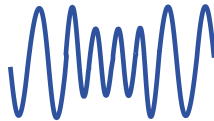

Undervoltage Solutions
Uninterruptible Power for Drives
(DC Bus Ride-Thru)
Voltage Regulators
Chargers and Dischargers
Energy Storage

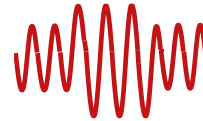

Overvoltage Solutions
Braking Transistors
Braking Resistors
Transistor/Resistor Combo
Line Regeneration
Dynamic Braking for Servo Drives

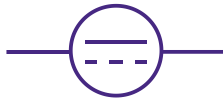

Common Bus Solutions
Single Phase Power Supplies
3-Phase Power Supplies
Common Bus Diodes



Portable Maintenance Solutions
Capacitor Formers
Capacitor Testers

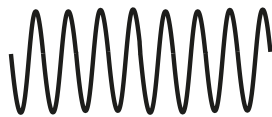

Power Quality Solutions
12 and 18 Pulse Kits



Green Solutions
Line Regeneration

This page intentionally left blank.

1. INTRODUCTION	7
1.1. Who Should Use	7
1.2. Purpose and Scope.....	7
1.3. Manual Version and Change Record.....	7
Figure 1-1: M3628UCT	7
1.4. Symbol Conventions Used in this Manual and on Equipment	8
2. PRODUCT DESCRIPTION	9
2.1. Related Products	9
2.2. Part Number Breakdown	10
Figure 2-1: Example of Part Number Breakdown	10
Table 2-1: Max Output Voltage	10
Table 2-2: Input Voltage.....	10
2.3. General Specifications	11
Table 2-3: General Specifications Table.....	11
General Precautions and Safety Warnings	12
3. INSTALLATION INSTRUCTIONS	13
3.1. Environment	13
3.2. Wiring and Customer Connections.....	13
3.2.1. Power Wiring	13
Figure 3-1: M3628UCT	13
3.2.1. Kelvin Connections.....	13
3.2.2. Source Considerations.....	14
3.2.3. Load Considerations.....	14
4. OPERATION	15
4.1. Functional Description	15
4.2. Architecture and Circuit Schematic.....	15
Figure 4-1: M3628UCT Schematic.....	15
4.3. Hardware Features	15
4.3.1. AC Power Input Connector.....	15
4.3.2. DC Output and Measurement Connectors	16
4.3.3. Display	16
4.3.4. Indicator LEDs.....	16
4.3.5. Directional Buttons	16
4.3.6. Enter and Cancel Button	16
4.3.7. Voltage Present Indicator.....	16
4.3.8. Power Switch / Circuit Breaker.....	16
4.3.9. Safety Bleeder Resistor	17
4.4. Modes, Screens & Menu Navigation.....	17
Figure 4-1: M3628UCT Interface Screen Tree	17
4.4.1. Status/Idle.....	18
4.4.2. Main Menu	18
Figure 4-3: M3628UCT Example Test Cycle.....	18
Figure 4-4: M3628UCT Example Measurement Stage	19
Figure 4-5: M3628UCT Example V-I Curve and Operating Area	20
4.5. Faults22	
4.5.1. Over-Current	22
4.5.2. Over-Voltage.....	22
4.5.3. DC Bus Out of Range	22
4.5.4. Over-Temperature	22

4.5.5. Timeout	23
5. TROUBLESHOOTING	24
Table 5-1: Troubleshooting.....	25
6. ENGINEERING DATA.....	27
6.1. Ratings Chart	27
Table 6-1: Ratings Chart.....	27
Table 6-2: Dimensions	27
7. APPLICATION NOTES.....	29
7.1. Typical Capacitor Testing Procedure	29

1. INTRODUCTION

1.1. WHO SHOULD USE

This manual is intended for use by trained personnel responsible for maintaining or testing ultra-capacitor cells and modules.

Please keep this manual for future reference.

1.2. PURPOSE AND SCOPE

This manual is a user's guide for the model M3628UCT. It will provide the user with the necessary information to successfully connect and operate the M3628UCT.

In the event of any conflict between this document and any publication and/or documentation related to any associated hardware (capacitor bank, etc.), the latter shall have precedence.

1.3. MANUAL VERSION AND CHANGE RECORD







The initial release for this manual is Rev 00a.

Updated section 4.5 in Rev 00b.

Figure 1-1: M3628UCT



1.4. SYMBOL CONVENTIONS USED IN THIS MANUAL AND ON EQUIPMENT

	<p>Earth Ground or Protective Earth</p>
	<p>AC Voltage</p>
	<p>DC Voltage</p>
 <p>DANGER!</p>	<p>DANGER: Electrical hazard - Identifies a statement that indicates a shock or electrocution hazard that must be avoided.</p>
 <p>DANGER!</p>	<p>DANGER: Identifies information about practices or circumstances that can lead to personal injury or death, property damage, or economic loss.</p>
 <p>CAUTION!</p>	<p>CAUTION: Identifies information about practices or circumstances that can lead to property damage, or economic loss. Attentions help you identify a potential hazard, avoid a hazard, and recognize the consequences.</p>
 <p>CAUTION!</p>	<p>CAUTION: Heat or burn hazard - Identifies a statement regarding heat production or a burn hazard that should be avoided.</p>

2. PRODUCT DESCRIPTION

As ultra-capacitors age and wear, their internal chemistries change, leading to a decrease in capacitance and efficiency. It is important to be able to measure capacitance and equivalent series resistance (ESR), and thus estimate the remaining useful life of your capacitor bank or constituent cells/modules. This can help reduce expensive pre-emptive replacement. Capacitors stored for long periods of time also display chemistry changes, which gradually reduces capacitance and increases ESR.

The Bonitron M3628UCT is a portable, digitally controlled DC power supply and capacitor test system with a variable output voltage and current limit. It can perform accurate, informative measurements of an ultra-capacitor's capacitance and ESR. This product may be used for many purposes, including a general purpose voltage/current source, charging and discharging capacitors, and measuring capacitance and ESR.

2.1. RELATED PRODUCTS

M3528 ULTRA CAPACITOR/ BATTERY CHARGER

The M3528 charger can charge strings of batteries or ultra capacitors to voltages required for industrial and commercial applications. AC or DC input is available, along with separate float and equalization charge levels. The charger is current limited, and designed for use in integrated storage and backup systems, but can also be used in bench or mobile systems.

KIT 3628T ULTRA CAPACITOR DISCHARGER

Large capacitor banks store huge amounts of energy, and can be a hazard when systems are shut down for system maintenance. The KIT 3628T system discharges capacitor banks to safe working levels quickly, allowing work on the system to begin in seconds, rather than hours.

M3628PCF PORTABLE CAPACITOR FORMER

The M3628 portable capacitor former can be used to charge or discharge capacitor banks as large as 50 kJ. The output voltage is manually variable between 0 and 800 VDC, and the system is capable of supplying 1 ADC continuously. The unit can also be used for reforming disused capacitors.

M3628ACF AUTOMATIC CAPACITOR FORMER

The M3628ACF automatic capacitor former can be used to reform capacitor banks as large as 150 kJ. The output voltage is programable between 0 and 1000 VDC, and is capable of supplying 1 ADC continuously.

2.2. PART NUMBER BREAKDOWN

Figure 2-1: Example of Part Number Breakdown

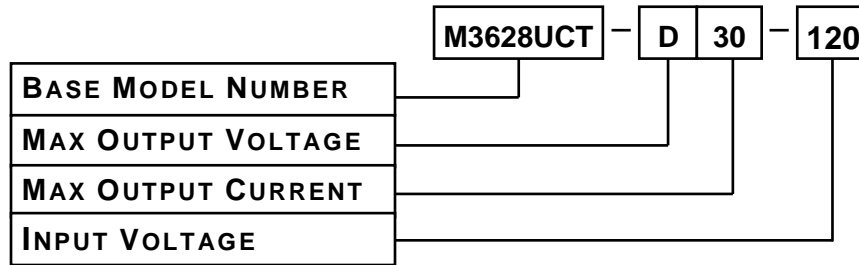

BASE MODEL NUMBER

The base model number for all Ultra-Capacitor Cell Testers is M3628UCT.

MAX OUTPUT VOLTAGE RATING

The Max Output Voltage rating indicates the maximum DC output voltage the unit can supply, which is indicated by a code letter.

Table 2-1: Max Output Voltage

RATING CODE	VOLTAGES (DC VOLTAGE OUTPUT)
D	20VDC out

MAX OUTPUT CURRENT RATING

The Max Output Current rating indicates the maximum DC current the unit can supply at its maximum voltage.

INPUT VOLTAGE

A three digit code represents the input voltage that should be used.

Table 2-2: Input Voltage

RATING CODE	INPUT VOLTAGE
120	110-120 VAC
240	220-240 VAC

2.3. GENERAL SPECIFICATIONS

Table 2-3: General Specifications Table

PARAMETER	SPECIFICATION
Input Voltage	110-120 VAC 1Ø
Test Voltage Range	2.0-20.0VDC
Test Current Range	1-30ADC
Minimum Test Capacitance	1F
Maximum Test Capacitance	6,500F
Minum Measurable ESR	0.1mΩ
Maximum Measurable ESR	500mΩ
Maximum Test Time	90 minutes
Controls	Six display soft keys
Display	Four line, eighty character LCD (4x20)
Unit Size (H x W x D)	22.0" x 13.9" x 9.0"
Weight	30lbs
Storage Temp	-20°C to + 65°C
Humidity	Below 90% non-condensing
Atmosphere	Free of corrosive gas and conductive dust

GENERAL PRECAUTIONS AND SAFETY WARNINGS



- **THIS UNIT PRODUCES VOLTAGES CAPABLE OF CAUSING INJURY OR DEATH!**
- **FOR USE BY QUALIFIED AND TRAINED PERSONNEL ONLY!**
- **IMPROPER OPERATION OF THE PRODUCT OR IGNORING THESE WARNINGS MAY RESULT IN SERIOUS BODILY INJURY OR DEATH!**
- **BEFORE CONNECTING THE M3628UCT TO A CAPACITOR, ENSURE THAT THE CELL OR MODULE IS FULLY DISCHARGED BY CHECKING WITH A VOLTMETER.**
- **CONNECTING THE M3628UCT'S VOLTAGE OUTPUT TO A LOAD WITH THE POLARITY REVERSED CAN CAUSE DAMAGE TO YOUR EQUIPMENT AND POTENTIALLY CREATE A FIRE OR EXPLOSION HAZARD, THREATENING LIVES. ENSURE THAT THE POSITIVE AND NEGATIVE TERMINALS ON BOTH THE SOURCE AND LOAD ARE POSITIVELY IDENTIFIED AND CORRECTLY CONNECTED BEFORE OPERATION.**
- **NEVER OPERATE THIS PRODUCT WITH THE ENCLOSURE COVER REMOVED.**



- **NEVER ATTEMPT TO SERVICE THIS PRODUCT.**
- **CERTAIN PARTS INSIDE THIS PRODUCT MAY GET HOT DURING OPERATION.**
- **BEFORE CONNECTING THIS DEVICE TO ANY OTHER PRODUCT, BE SURE TO REVIEW ALL DOCUMENTATION OF THAT PRODUCT FOR PERTINENT SAFETY PRECAUTIONS.**

ANY QUESTIONS AS TO APPLICATION, INSTALLATION, OR SERVICE SAFETY SHOULD BE DIRECTED TO THE EQUIPMENT SUPPLIER.

3. INSTALLATION INSTRUCTIONS

3.1. ENVIRONMENT

While closed, the M3628UCT is water, dust, and crush resistant. When open and in operation, the unit should be used only in dry, clean areas. Ensure that the interior of the unit casing is kept dry.

3.2. WIRING AND CUSTOMER CONNECTIONS

3.2.1. POWER WIRING

The Power Input connector accepts 50-60Hz from the included standard C13 power cable. The DC Output connectors are PowerPoles that supply user selected DC voltage and currents. Two standard cable assemblies using alligator clips and ring lugs are included.

Figure 3-1: M3628UCT

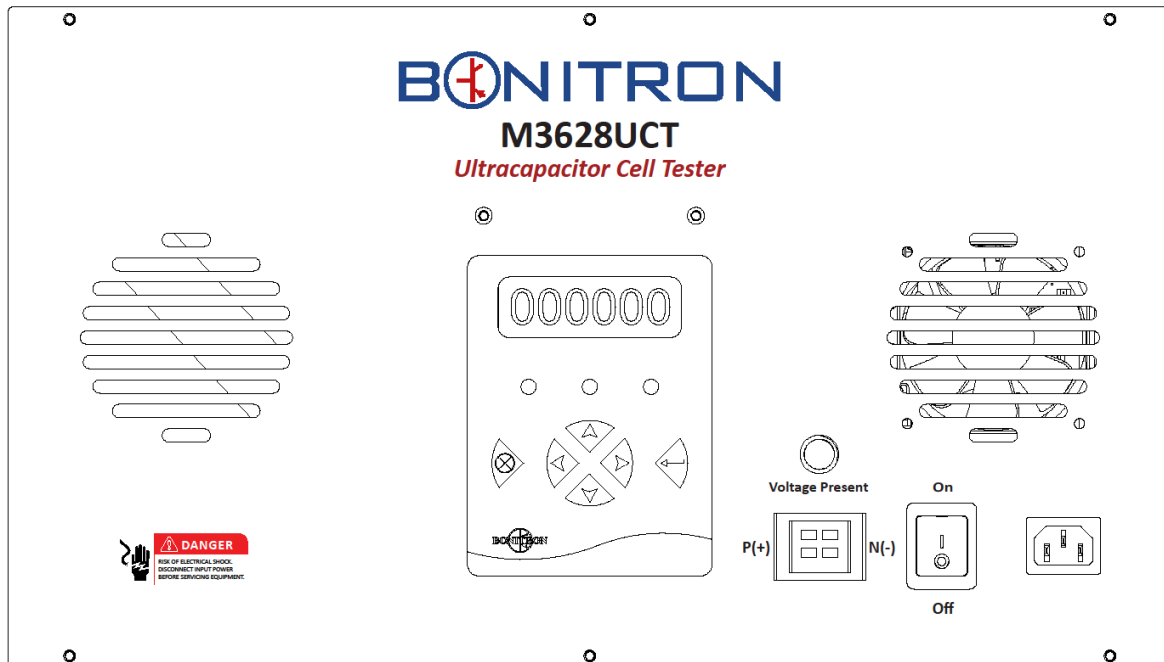

3.2.1. MEASUREMENT CONNECTIONS

In addition to the DC output connections, two clip leads are provided for the system to make differential voltage measurements through Kelvin connections. On the standard cable assembly, this is done connecting the clip leads as close to the capacitor as possible, thus avoiding the voltage drop from the high current flowing through the cables and power connections.

3.2.2. SOURCE CONSIDERATIONS

Input voltage should not exceed the rating—120VAC or 240VAC depending on model—or damage to the unit may result. To guarantee correct system operation at all output voltages, the source must be capable of supplying at least 10 amps for 120VAC supply or 5 amps for a 240VAC supply. Failure to meet the minimum current requirement may result in improper operation. Connecting the unit to an input voltage other than that specified on the unit faceplate may also result in improper operation or damage to the unit.

3.2.3. LOAD CONSIDERATIONS

In order to obtain the most accurate measurements, the capacitor under test would ideally be charged to its full rated voltage. However, the recommendation is to test capacitors at 95% of their rated voltage to allow a margin for device error and capacitor tolerances.

4. OPERATION

4.1. FUNCTIONAL DESCRIPTION

The M3628UCT is a digitally controlled DC supply capable of sourcing and sinking 1 to 30 amps between 2 and 20VDC. The unit is powered by standard 50-60 Hz 120VAC/240VAC. The output voltage and current is set by the digital interface panel on the front of the unit. The unit is capable of safely charging and discharging connected capacitors with a constant current as well as running a complete charge/hold/discharge test cycle appropriate for ultra-capacitors. When a capacitor is discharged, the unit will calculate and display the capacitance and ESR of the capacitor.

4.2. ARCHITECTURE AND CIRCUIT SCHEMATIC

Electrically, the M3628UCT is a current and voltage regulated, bi-directional DC-DC converter with response times on the order of milliseconds. Additionally, in order to manage the flow of power into the system during discharge operations, the M3628UCT includes an integrated resistor bank and regulating chopper capable of dissipating 600W continuously.

Figure 4-1: M3628UCT Schematic

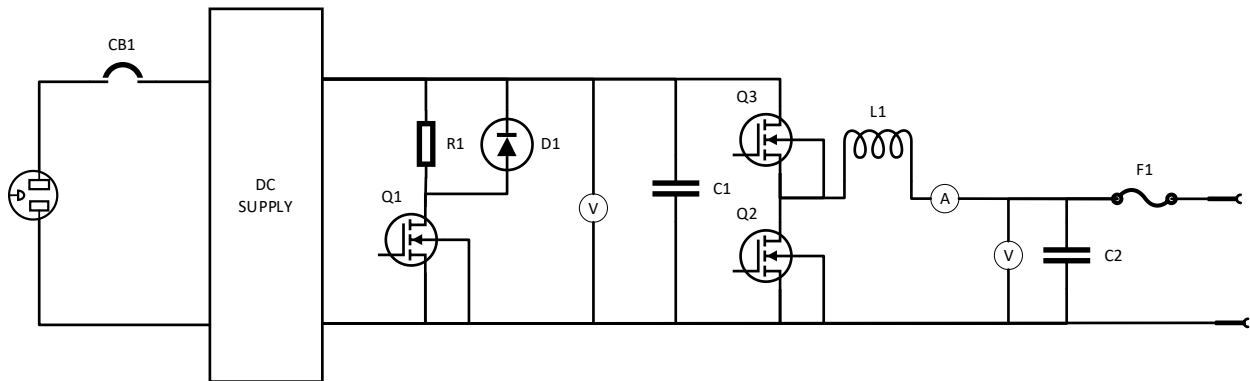

4.3. HARDWARE FEATURES

4.3.1. AC POWER INPUT CONNECTOR

The M3628UCT is equipped with a standard IEC C14 connector for input power. This connector mates with a standard C13 cable, commonly used with desktop computers, to provide power to the unit.

4.3.2. DC OUTPUT AND MEASUREMENT CONNECTORS

Four PowerPole connectors provide the user with DC output voltage between 0 and 20VDC, a charge/discharge path for the current to and from the capacitor being tested, and precision Kelvin measurements for ESR. The standard cables shipped with the system include either two high-current alligator clips or ring terminals, and two measurement clip leads.

4.3.3. DISPLAY

The digital display presents the user with information about the present status of the system, including the output voltage and current. The display also presents the user with options to control system operation, including charging and discharging attached capacitors.

4.3.4. INDICATOR LEDs

There are three LEDs below the Display to indicate the operational status of the unit.

- Green: Unit is powered on.
- Yellow: Unit is active.
- Red: A fault has occurred. Check display for description.

4.3.5. DIRECTIONAL BUTTONS

Each of the four buttons corresponds to a direction, *up*, *down*, *left* or *right*. *Up* and *down* move the cursor among menu items. On screens where numbers are input by the user, the *left* and *right* buttons move the cursor, while the *up* and *down* buttons change the selected digits. On some screens, certain buttons may have no function at all.

4.3.6. ENTER AND CANCEL BUTTON

The green *enter* button selects menu options. On most screens, the *cancel* button will return you to the previous screen. While the system is active, the *cancel* button will halt the operation and return to an idle state.

4.3.7. VOLTAGE PRESENT INDICATOR



Do not use this light as an indication that the output is safe to work on! Always check the output with a working voltmeter before servicing equipment, as the lamp may be malfunctioning!

ELECTROCUTION HAZARD! *This unit produces potentially dangerous voltages from low impedance sources that can cause injury or death. Always follow safety protocols when working with energized equipment and charged capacitors!*

A red light indicates that there is voltage on the DC output of the unit. Do not touch the output connectors or the attached equipment while this light is on, as electric shock could result.

4.3.8. POWER SWITCH / CIRCUIT BREAKER

The Power Switch also acts as a circuit breaker to protect from overload conditions. If the breaker is tripped, you can reset it by simply turning the switch back on.

4.3.9. SAFETY BLEEDER RESISTOR

In the event power is lost to the unit, but a charged capacitor is connected, a 230Ω resistor will automatically be connected to the output terminals, slowly discharging the capacitor and the “Voltage Present” LED will continue to function. If the voltage is sufficiently high, the capacitor will also back-feed the system, allowing it to remain powered in the absence of external power.

4.4. MODES, SCREENS & MENU NAVIGATION

Many screens are menus allowing access to other screens, or lists presenting a number of options. The presently selected item on the menu is indicated by a ‘>’ cursor. This selection indicator is moved using the *up* and *down* buttons. If a line on the menu represents another screen, that screen is accessed with the *Enter* button. The *Cancel* button will return the display to the parent screen. See Figure 4-3.

Figure 4-2: M3628UCT Interface Screen Tree

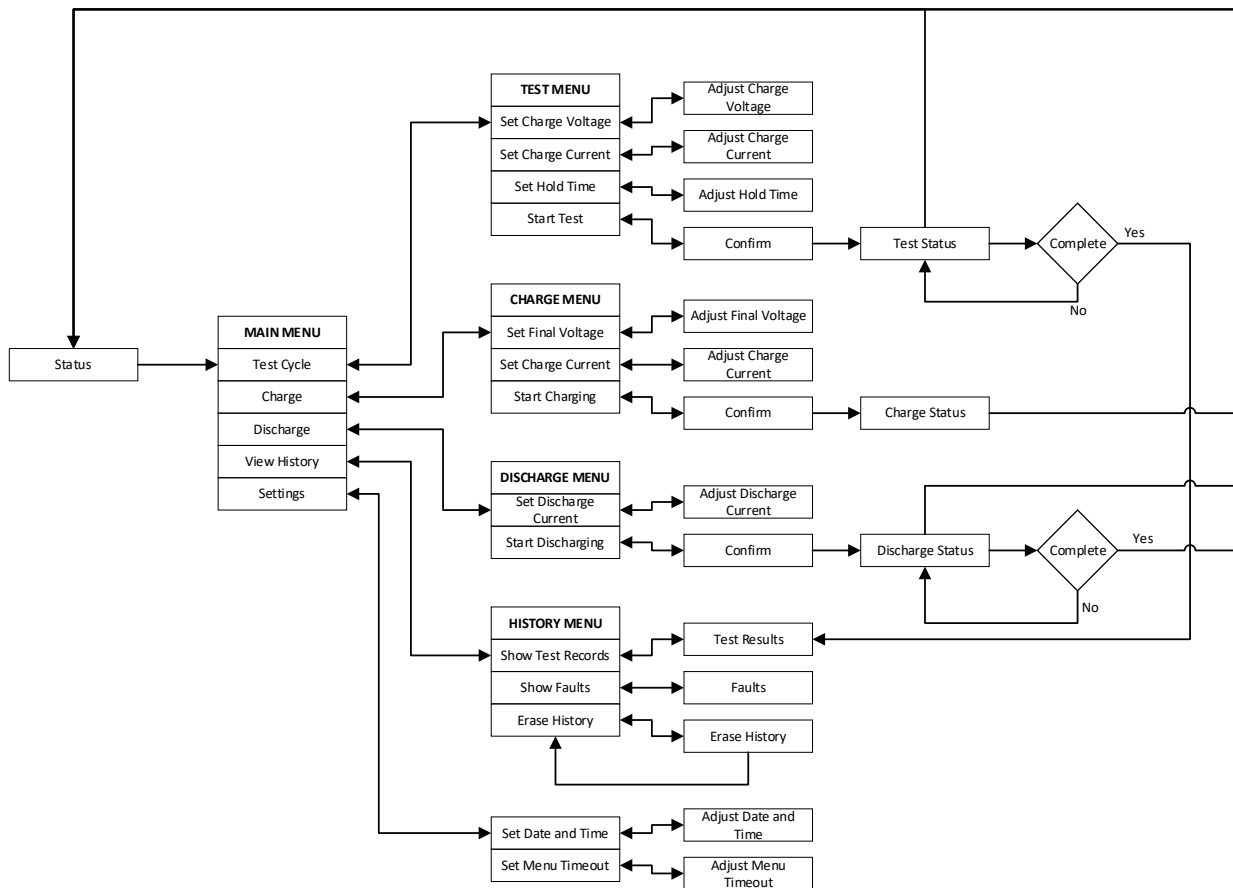

4.4.1. STATUS/IDLE

This is the default screen while the system is idle, displaying the present terminal voltage and indicating that the system is ready for operation. If the system is idle in another screen and no button is pressed for a period of time, the system will transition to this screen. Pressing *Enter* will transition to the main menu.

4.4.2. MAIN MENU

The Test Cycle menu, Charge Menu, Discharge Menu, and History may be accessed from the Main Menu.

4.4.2.1. TEST MENU

From this menu, the user may input the variables necessary to execute a complete capacitor test cycle. A test cycle is broken into three distinct stages: charging the capacitor with a constant current, holding the set voltage for a specified amount of time, then discharging the capacitor at the same constant current, during which measurements are taken. See Figures 4-3 and 4-4 for detailed examples. In the event that the voltage drops too rapidly during discharge to make accurate capacitance measurements, the test will return to the hold stage, then attempt the measurement again at a reduced current. The ESR measurement uses a pulse technique and will similarly automatically adjust the current to an appropriate value.

Figure 4-3: M3628UCT Example Test Cycle

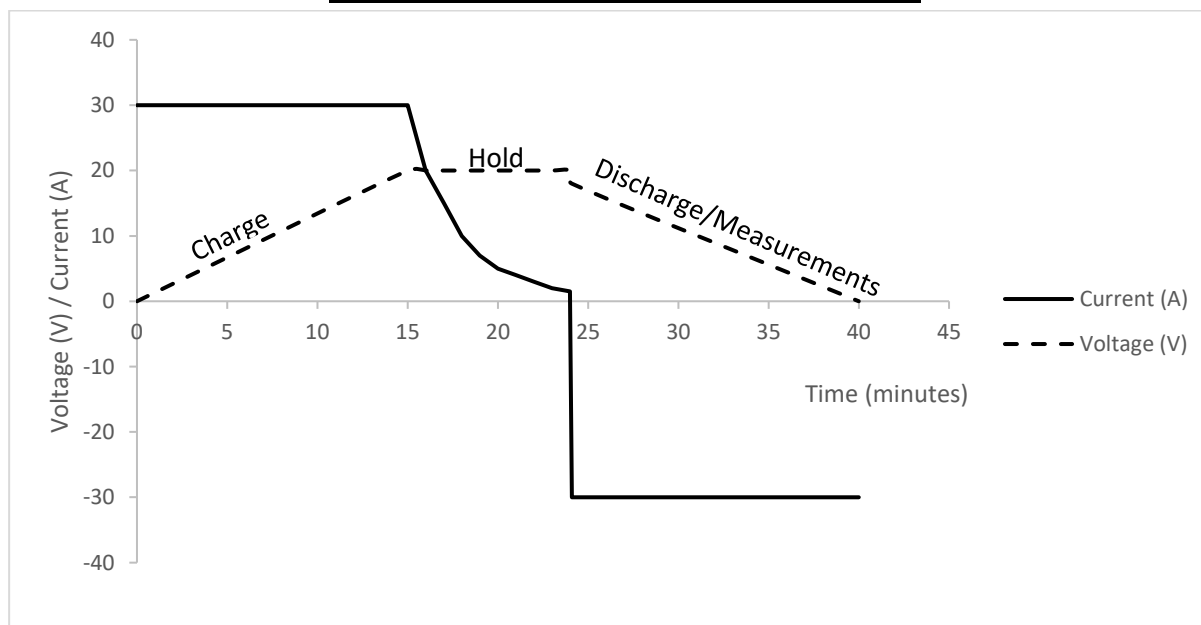
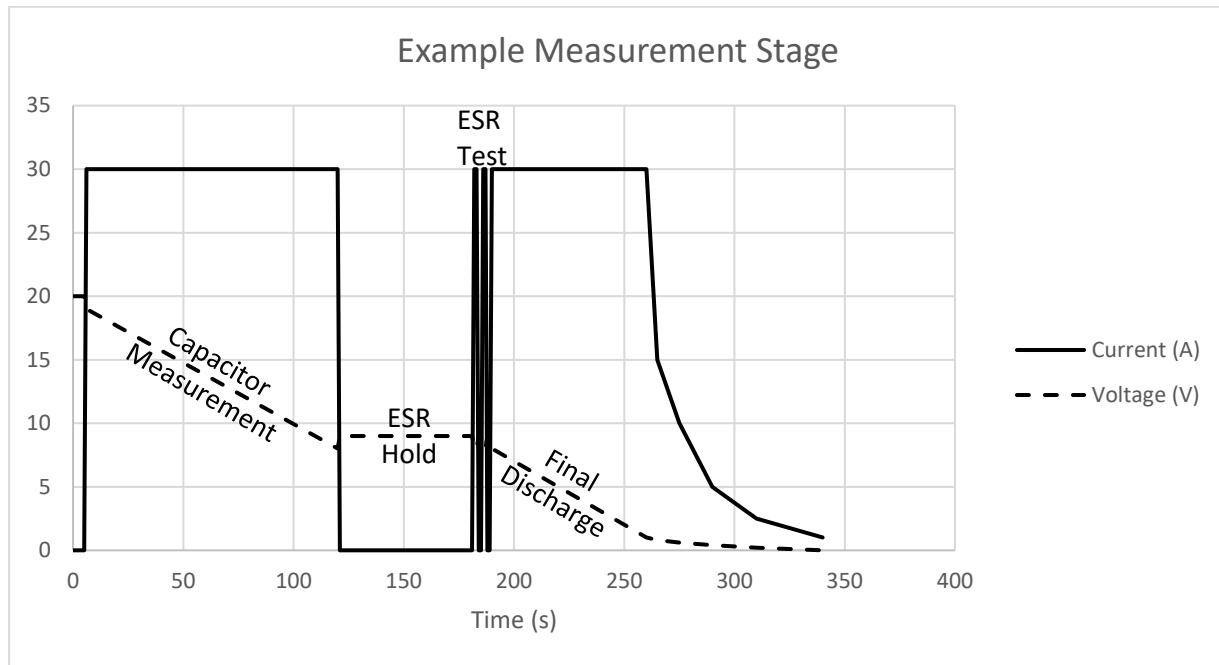

Figure 4-4: M3628UCT Example Measurement Stage**4.4.2.1.1. SET CHARGE VOLTAGE**

From this screen the user may set the final voltage they wish to charge the load to. The right and left buttons control which digit is presently being edited, and the up and down buttons increment or decrement that digit. Pressing Enter will exit this screen and save the voltage.

4.4.2.1.2. SET CHARGE CURRENT

From this screen the user may set the maximum current with which they wish to charge the load. The *right* and *left* buttons control which digit is presently being edited, and the *up* and *down* buttons increment or decrement that digit. Pressing Enter will exit this screen and save the current.

4.4.2.1.3. SET HOLD TIME

From this screen the user may set the number of minutes the charge voltage will be held. The right and left buttons control which digit is presently being edited, and the up and down buttons increment or decrement that digit. Pressing Enter will exit this screen and save the hold time. The maximum hold time is 30 minutes.

4.4.2.1.4. START TEST

At this screen the user is asked to confirm the charge voltage and current, and begin charging the output.

4.4.2.1.4.1. TEST STATUS

This screen displays the present output voltage (at the panel connector), current, stage of the test, and a timer or stopwatch. The stopwatch resets for the charging, capacitance measurement, and discharging stage transitions, subsequently displaying the time the system has been in the present stage. Alternately, a timer appears in the holding and ESR stages, showing the time remaining in the stage. The test may be halted at any time by pressing the Cancel button.

4.4.2.2. CHARGE MENU

The user may set the charge voltage and current, and initiate charging from this menu. Operating the system in charge mode causes it to behave as a current limited voltage source. An example V-I curve is shown in Figure 4-5 below.

Figure 4-5: M3628UCT Example V-I Curve and Operating Area

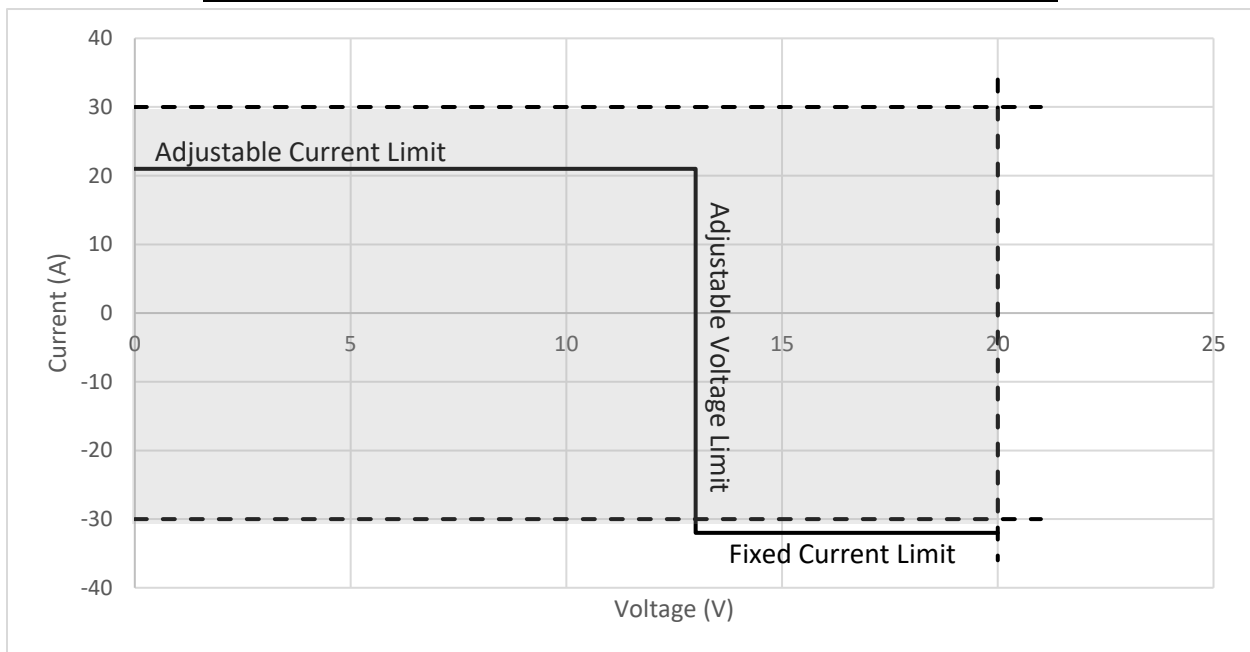

4.4.2.2.1. SET FINAL VOLTAGE

From this screen the user may set the voltage they wish to charge the load to. The right and left buttons control which digit is presently being edited, and the up and down buttons increment or decrement that digit. Pressing Enter will exit this screen and save the voltage.

4.4.2.2.2. SET CHARGE CURRENT

From this screen the user may set the maximum current with which they wish to charge the load. The *right* and *left* buttons control which digit is presently being edited, and the *up* and *down* buttons increment or decrement that digit. Pressing *Enter* will exit this screen and save the current.

4.4.2.2.3. START CHARGING

At this screen, the user is asked to confirm the parameters of the selected charge mode to begin charging the capacitor.

4.4.2.2.3.1. CHARGING STATUS

This screen displays the present output voltage (at the panel connector), and current. Charging may be halted by pressing the *Cancel* button.

4.4.2.3. DISCHARGE MENU

The user may set the discharge current and initiate discharge from this menu. In this mode, the system behaves as an adjustable current sink.

4.4.2.3.1. SET DISCHARGE CURRENT

From this screen the user may set the maximum current with which they wish to discharge the load. The *right* and *left* buttons control which digit is presently being edited, and the *up* and *down* buttons increment or decrement that digit. Pressing *Enter* will exit this screen and save the current.

4.4.2.3.2. START DISCHARGING

At this screen, the user is asked to confirm the parameters of the selected discharge mode to begin discharging the capacitor.

4.4.2.3.2.1. DISCHARGE STATUS

This screen displays the present output voltage (at the panel connector), and current. Discharging may be halted by pressing the *Cancel* button.

4.4.2.4. VIEW HISTORY

The user may navigate to previous test records, fault records, or erase existing records from this menu.

4.4.2.4.1. SHOW TEST RECORDS

Takes the user to the most recent test record and allows up to 50 test records to be accessed. The *right* and *left* buttons increment and decrement the displayed test record, and the *up* and *down* buttons move between the first and second page of each record.

4.4.2.4.2. SHOW FAULTS

Takes the user to the most recent fault record and allows up to 20 fault records to be accessed. The *right* and *left* buttons increment and decrement the displayed test record.

4.4.2.4.3. ERASE HISTORY

Takes the user to a page to confirm erasing all records. Pressing *Enter* erases all records; pressing *Cancel* exits to the previous page.

4.4.2.5. SETTINGS

The user may set the date and time or change the menu Idle Timeout duration from this menu.

4.4.2.5.1. SET DATE /TIME

Takes the user to a page which allows the present date and time to be input. The *right* and *left* buttons move the cursor digit and the *up* and *down* buttons increment and decrement the selected digit.

4.4.2.5.2. SET MENU TIMEOUT

Takes the user to a page which allows the Timeout Duration to be set. The Timeout Duration controls how long the system will wait idle in a screen before returning to the Status screen. The default setting is 60 seconds. The *right* and *left* buttons move the cursor digit and the *up* and *down* buttons increment and decrement the selected digit.

4.5. FAULTS

If a fault condition occurs, the "FAULT" LED will illuminate, and the display will indicate the nature of the fault. To clear a fault, the fault condition must be resolved and the user must press the red Cancel button. If a fault clears, the unit will return to the idle screen and operation may be resumed. Up to 20 previous faults may be recalled from the history menu.

4.5.1. OVER-CURRENT

This fault indicates that the output current has exceeded the designed operating range of the system. If the fault will not clear, your unit is likely damaged. Contact Bonitron for service options.

4.5.2. OVER-VOLTAGE

This fault indicates that the output voltage has exceeded the designed operating range of the system. If the fault will not clear, your unit is likely damaged. Contact Bonitron for service options.

4.5.3. DC BUS OUT OF RANGE

This fault indicates that the internal supply bus is not within the operating range of the system. If the fault will not clear, your unit is likely damaged. Contact Bonitron for service options.

4.5.4. OVER-TEMPERATURE

This fault indicates that at least one of the switching transistors has exceeded a safe operating temperature. If the fault will not clear after allowing time to cool, your unit is likely damaged. Contact Bonitron for service options.

4.5.5. **TIMEOUT**

This fault indicates that the system has spent more than 30 minutes in a particular stage.

This page intentionally left blank.

5. TROUBLESHOOTING

If a problem occurs on start-up or during normal operation, refer to the problems described below. If a problem persists after following the steps below, contact Bonitron Tech Support, the product supplier or your system integrator for assistance.

Repairs or modifications to this equipment are to be performed by Bonitron approved personnel only. Any repair or modification to this equipment by personnel not approved by Bonitron will void any warranty remaining on this unit.

Table 5-1: Troubleshooting

Unit will not power up	<ul style="list-style-type: none"> • Ensure that the input power cable is connected firmly to the unit and to a functioning power source at the correct voltage. • Make sure the input circuit breaker/switch has not tripped.
Output voltage never rises above zero while charging a capacitor	<ul style="list-style-type: none"> • Ensure that the commanded current is sufficiently high to appreciably increase the voltage in a timely manner. • Check the connections between the unit and the load, making sure that the connection is solid, that the polarity is correct, and that nothing is shorting out the terminals. • Run the system with the load disconnected and verify it reaches the commanded voltage. If not, or if the terminal voltage as measured with a separate voltage meter does not match the displayed voltage, the internal circuitry may need service. Consult Bonitron for service options.
Display shows no output current while charging a capacitor	<ul style="list-style-type: none"> • Check the output connections to make sure there is good contact to the load. • Make sure there is voltage at the output terminals first checking the display, then verifying with a voltage meter. • Run the system with the load disconnected and the output terminals shorted together to verify it produces the commanded current. If not, the internal circuitry may need service. Consult Bonitron for service options.
Over-temp fault activated during operation	<ul style="list-style-type: none"> • Remove any obstructions blocking the vent • Ensure that the fan turns on when the system is activated, and that the air drawn into the fan is less than 40°C • If the system continues to overheat, the internal circuitry may need service. Consult Bonitron for service options.
Time-out fault during test	<ul style="list-style-type: none"> • Check the connections between the unit and the load, making sure that the connection is solid, that the polarity is correct, and nothing is shorting the capacitor being tested. • Large capacitors and capacitors with high ESRs may take a long time to charge and discharge, possibly exceeding the 30 minute limit imposed on each portion of the test cycle. • Excessively leaky loads may not allow the charging current to drop below the 1A requirement to move to the "Hold" phase of a test cycle. Check for parasitic loads.
The ESR measurement is too high	<ul style="list-style-type: none"> • Ensure that the test cable's clip leads are firmly connected to the test capacitor terminals as close as possible to the capacitor itself.

M3628UCT

Red voltage present light is ON when no voltage is displayed	<ul style="list-style-type: none">• The voltage present light indicates that there is voltage between the output terminals of the unit. If the display indicates that no voltage is present, the internal circuitry may need service. Consult Bonitron for service options.
Red voltage present light never turns on regardless of output voltage	<ul style="list-style-type: none">• Check the output voltage with a separate voltmeter. If the voltage is above 2VDC, your unit may require service. Contact Bonitron.



Always monitor the output voltage while operating the unit. Ensure that the attached loads do not exceed their rated voltage, as catastrophic damage, injury, or death may occur.

6. ENGINEERING DATA

6.1. RATINGS CHART

Table 6-1: Ratings Chart

Input Voltage	120VAC/240VAC
Output Voltage	0 - 20VDC
Output Current	0 - 30A

Table 6-2: Dimensions

Height	9 in. (with top closed)
Width	13.9 in.
Depth	22.0 in.

This page intentionally left blank.

Appendix

7. APPLICATION NOTES

7.1. TYPICAL CAPACITOR TESTING PROCEDURE

Ultra/super capacitors undergo chemical changes when stored or used for long periods of time, steadily losing capacitance and increasing in ESR. If wear continues unchecked, these capacitors can fail or no longer store enough energy to perform their intended function, potentially causing catastrophic damage. Capacitor lifetime is heavily dependent on use and ambient conditions, and thus difficult to predict. Periodically measuring the capacitance of a cell or module can help quantify the wear on and remaining lifetime of the capacitor, helping avoid catastrophic failure without periodically replacing the entire bank.

A short description of how to use the M3628UCT to test a capacitor cell or module is given below.

1. Ensure the capacitor is discharged.
2. Apply power to the M3628UCT.
3. Connect the high-current leads to the capacitor as directly as possible. Each additional wire and interconnect will increase the resistance and prolong charging and discharging.
4. Connect the clip leads directly to the capacitor terminals. The clip leads are used to measure the voltage between the two points in response to a forced current, thus allowing ESR to be measured. Everything between these two points will be included in the ESR calculation.
5. Select "Test Cycle" from the main menu.
6. Set the charge voltage to 95% of the rated voltage of the capacitor.
7. Set the charge current to its maximum setting or the current rating of the capacitor, whichever is lower.
8. Set the hold time to at least 1 minute.
9. Begin charging the capacitor, listening for abnormal sounds or other indications in the capacitors or attached equipment. Monitor the current indicator to make sure the commanded current is reached, and the voltage indicator to see that the voltage is rising. Continually monitor the capacitor for abnormal signs, such as noise, heating, or smell.

IF AT ANY TIME ABNORMAL SIGNS ARE DETECTED, OR THE LOAD CAPACITORS ARE OVERVOLTAGED, PRESS CANCEL, THEN PROCEED TO DISCHARGE THE CAPACITOR IF POSSIBLE.

10. After the hold period is complete, the unit will discharge the load and calculate its capacitance and ESR. Wait until discharging is complete before disconnecting the load, indicated by the appearance of a test record. Record the calculated capacitance and ESR somewhere safe, along with the designation of the capacitor being tested. Multiple tests may be performed if desired, to ensure repeatability.
11. If the procedure is completed successfully, the capacitor bank or equipment can be returned to storage or put into use, as appropriate.

12. If the bank is put into service, test the capacitor bank periodically, on a schedule recommended by the capacitor manufacturer. Ensure that all tests are performed in a similar ambient temperature; otherwise comparison between results may not be valid. If over time the bank capacitance falls below the manufacturer-recommended percentage of the original recorded capacitance, discard and replace the capacitor.

This page intentionally left blank.
